

MB

PHONE: UPTON 0-4070

COLONIAL OPTICAL CO.

1954 SO. LA CIENEGA BLVD. ★ LOS ANGELES 34, CALIF.

Direct Importers

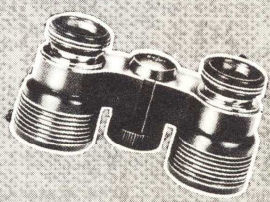
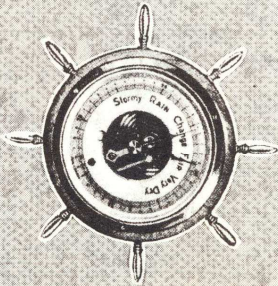
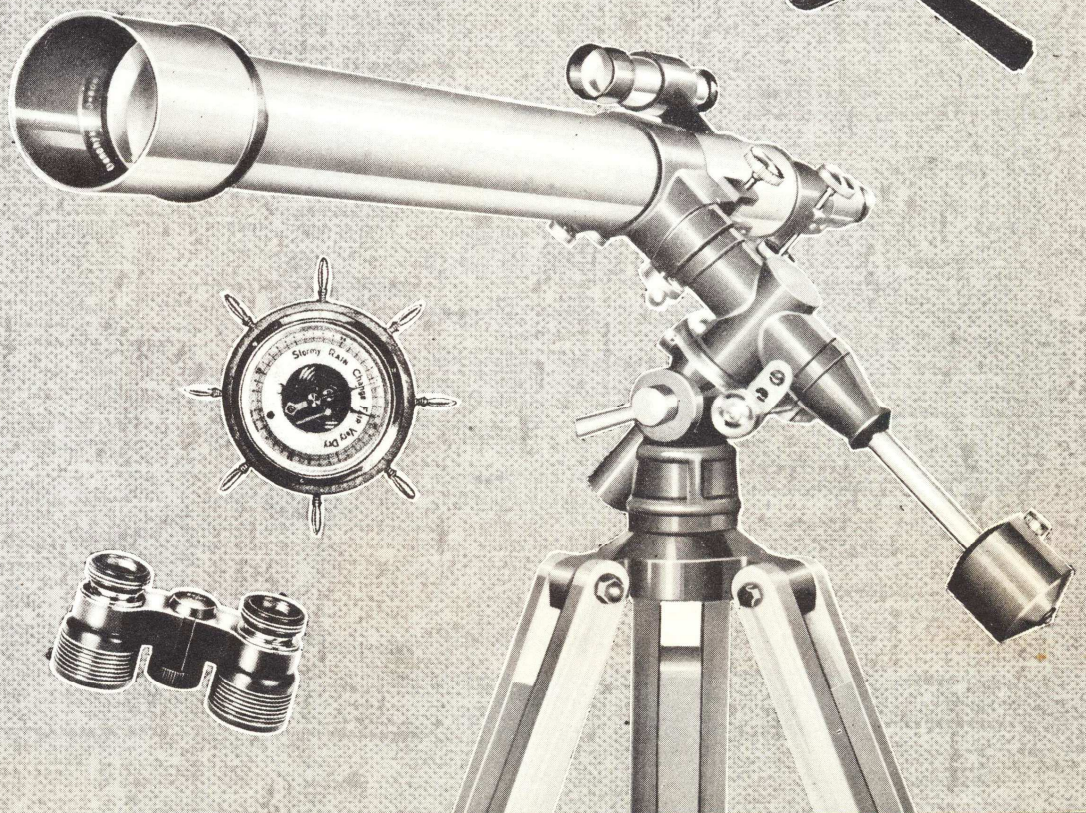
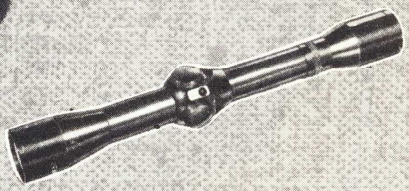
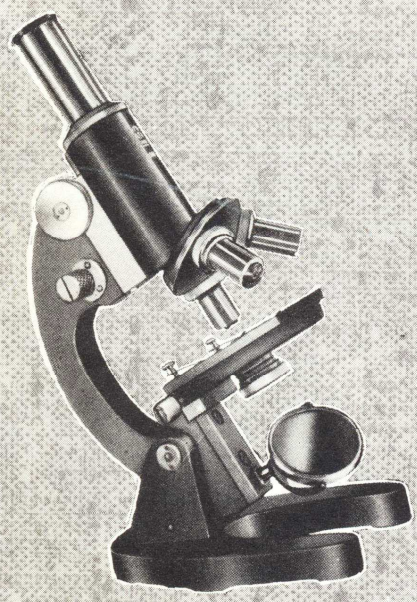

**1962
CATALOG No. 16**

MAYFLOWER

BINOCULARS

made in Japan

Fully Coated

Our Binoculars have "FULLY COATED" optics, not just partially coated.

MB

#101 IF
#102 CF

6x30

Mayflower

COATED — Individual Focus
Center Focus
Field at 1000 yds: 425 ft

Zeiss type



IF #103
CF #104

8x30

Mayflower

COATED — Individual Focus
Center Focus
Field at 1000 yds: 394 ft

Zeiss type



Now 11°

EXTRA WIDE ANGLE

#107

7x35 CF

B & L type

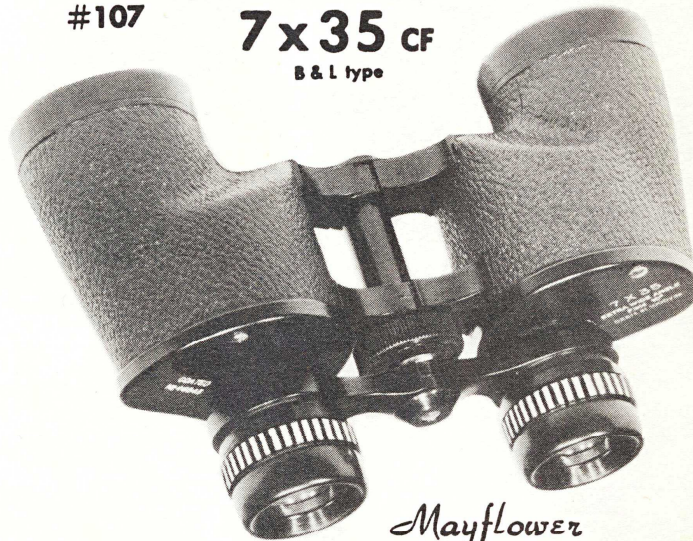

Mayflower

COATED — Center Focus
Field at 1000 yds: 578 ft

#114

7x35 CF

Mayflower

COATED — Center Focus
Field at 1000 yds: 375 ft

Zeiss type



#113

7x35 IF

Mayflower

COATED — Individual Focus
Field at 1000 yds: 375 ft

Zeiss type



#128

8x40 CF

Zeiss type

Mayflower

COATED — Center Focus
Field at 1000 yds: 364 ft

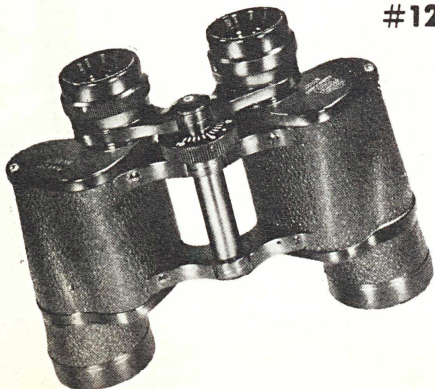

#106

B & L type

7x35 CF

Mayflower

COATED — Center Focus
Field at 1000 yds: 375 ft



2.

Furnished with HARD LEATHER CASES, Gift boxed.

COLONIAL OPTICAL COMPANY

1954 SOUTH LA CIENEGA BLVD. ★ LOS ANGELES 34, CALIF.

MAYFLOWER

BINOCULARS

made in Japan

Fully Coated

Our Binoculars have "FULLY COATED" optics, not just partially coated.

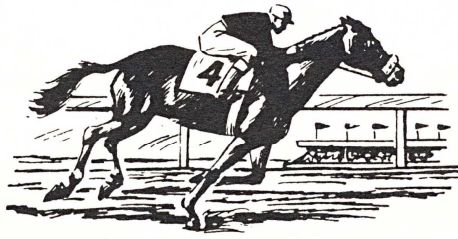

#112 **7x50** IF

Zeiss type

#110 **7x50** CF

Mayflower
Individual Focus
COATED — Center Focus
Field at 1000 yds: 375 ft

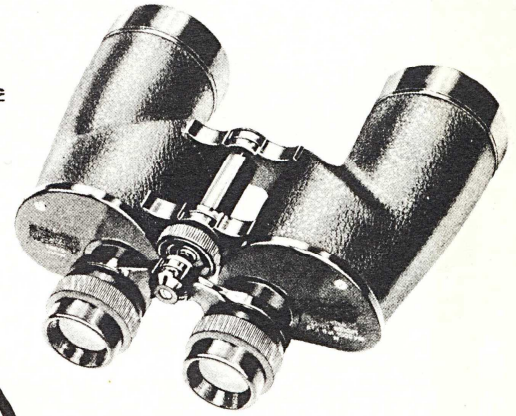

#109 **7x50** CF

B & L type

Mayflower
COATED — Center Focus
Field at 1000 yds: 375 ft



300M

#130



New

8-16x35 CF

Mayflower B & L type

COATED — Center Focus
Field at 1000 yds: 315 ft at 8x



Zeiss type

#120 **10x50** CF

Mayflower

COATED — Center Focus
Field at 1000 yds: 340 ft

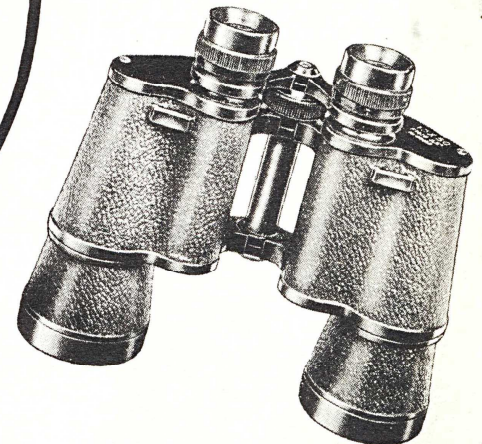

#122 **16x50** CF Zeiss type

Mayflower

COATED — Center Focus
Field at 1000 yds: 240 ft



Furnished with HARD LEATHER CASES, Gift boxed.

3.

COLONIAL OPTICAL COMPANY

1954 SOUTH LA CIENEGA BLVD. ★ LOS ANGELES 34, CALIF.

MAYFLOWER

MAGNESIUM BINOCULARS

made in Japan

Fully Coated
Our Binoculars have "FULLY COATED"
optics, not just partially coated.

#1018



8 x 30 CF

Mayflower

COATED — Center Focus
Field at 1000 yds: 394 ft

B & L type



Now **11°**

EXTRA WIDE ANGLE

7 x 35 CF

B & L type

#1007



MAGNESIUM

Mayflower

COATED — Center Focus
Field at 1000 yds: 578 ft

MAGNESIUM



#1006



B & L type

7 x 35 CF

Mayflower

COATED — Center Focus
Field at 1000 yds: 375 ft

4.

Furnished with HARD LEATHER CASES, Gift boxed.

#1029



8 x 40 CF

Mayflower

COATED — Center Focus
Field at 1000 yds: 364 ft

B & L type

EXTRA WIDE ANGLE

7 x 50 CF

B & L type



#1009

Mayflower

COATED — Center Focus
Field at 1000 yds: 525 ft

MAGNESIUM

MB

COLONIAL OPTICAL COMPANY

1954 SOUTH LA CIENEGA BLVD. ★ LOS ANGELES 34, CALIF.

Colonial

SUPERIOR GRADE

made in Japan

Fully Coated

As seen with the naked eye.



As seen through these powerful 7x35 binoculars



7x35 CF
Colonial B & L type

COATED — Center Focus
Field at 1000 yds: 375 ft

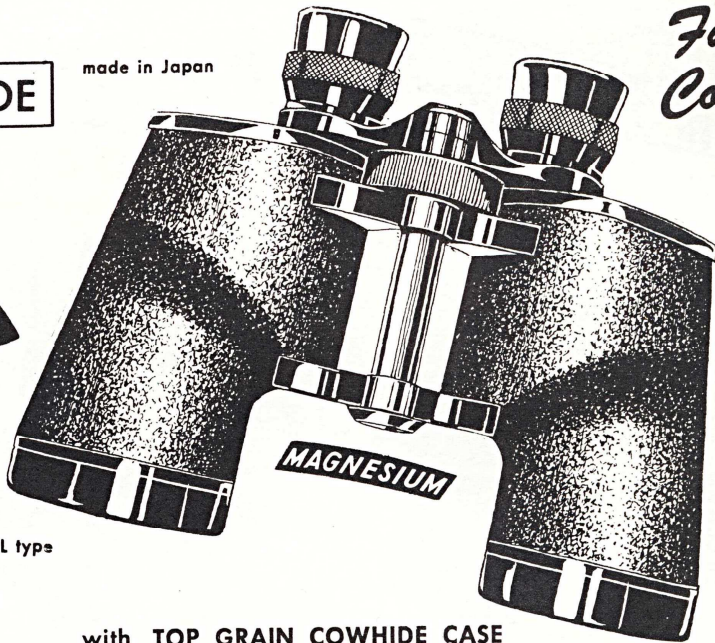

#203

with TOP GRAIN COWHIDE CASE



Spindler & Hoyer

IMPORTED FROM
GERMANY

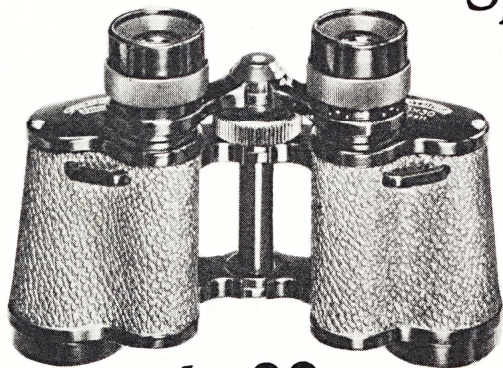

#301

6x30 CF

Spindler & Hoyer

15 ozs. Featherweight

COATED — Center Focus

Field at 1000 yds: 450 ft

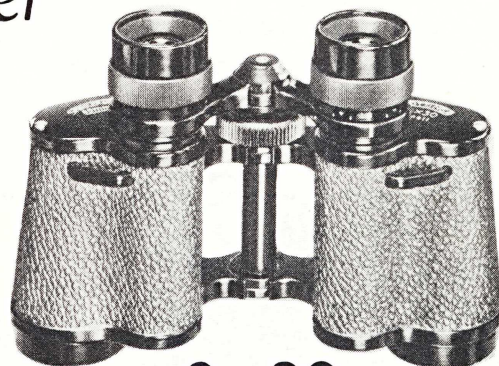

#302

8x30 CF

Spindler & Hoyer

15 ozs. Featherweight

COATED — Center Focus

Field at 1000 yds: 435 ft



#303

7x35 CF

Spindler & Hoyer

17 ozs. Featherweight

COATED — Center Focus

Field at 1000 yds: 400 ft



#304

7x50 CF

Spindler & Hoyer

35 ozs. Featherweight

COATED — Center Focus

Field at 1000 yds: 400 ft

Furnished with TOP GRAIN COWHIDE CASES

5.

COLONIAL OPTICAL COMPANY

1954 SOUTH LA CIENEGA BLVD. ★ LOS ANGELES 34, CALIF.

MAYFLOWER

MONOCULARS

made in Japan

Fully Coated

Our Binoculars have "FULLY COATED" optics, not just partially coated.

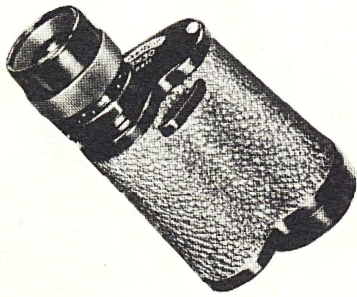

#147
Zeiss type **6x30**
Mayflower
COATED
Field at 1000 yds: 438 ft
with HARD LEATHER CASE

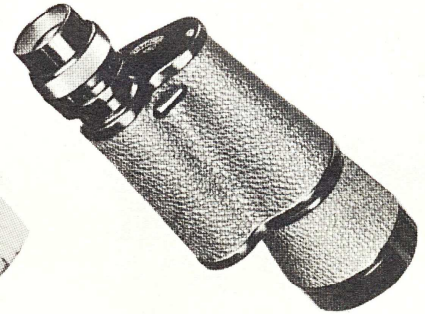

#150
Zeiss type **7x50**
Mayflower
COATED
Field at 1000 yds: 375 ft
with HARD LEATHER CASES

MB

MAYFLOWER

Miniature Binoculars

Coated Optics
made in Japan

#501
6x15 IF
Mayflower
COATED — Individual Focus
Field at 1000 yds: 370 ft
Size: 3 1/4 x 2"

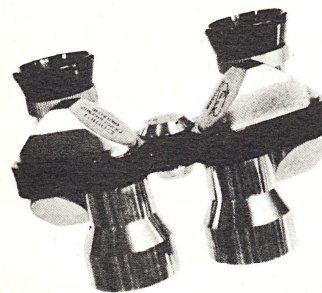

#502 IF **7x18** #503 CF
Mayflower
COATED — Individ Focus
Center Focus
Field at 1000 yds: 370 ft
Size: 3 1/4 x 2"

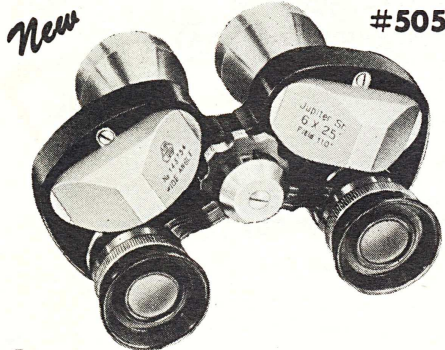
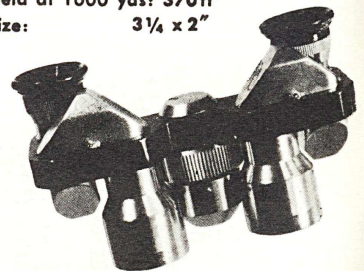

#505
Now
12°
EXTRA WIDE ANGLE
6x25 CF
Mayflower
COATED — Center Focus
Field at 1000 yds: 630 ft
Size: 4 1/2 x 2 3/4"



#504
EXTRA WIDE ANGLE
7x25 IF
Mayflower
COATED — Individual Focus
Field at 1000 yds: 525 ft
Size: 4 1/2 x 2 3/4"

6.

COLONIAL OPTICAL COMPANY

1954 SOUTH LA CIENEGA BLVD. ★ LOS ANGELES 34, CALIF.

BINOCULAR MOUNT



Will attach to any standard Tripod to hold Binocular stationary.
Ideal for observation purposes, where fixed object is being viewed.

#50

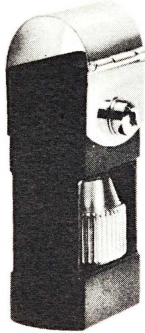

7x35 CF
NON-PRISMATIC BINOCULAR
Achromatic Objectives

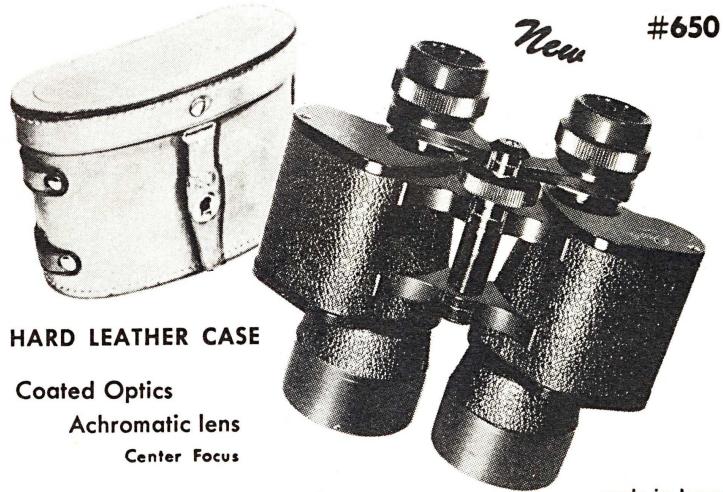

New #650

With **HARD LEATHER CASE**

Coated Optics
Achromatic lens
Center Focus

made in Japan

MAYFLOWER

New Zoom



#616

2-4x30 Mayflower

with **CENTER BREAK**
matching case, assorted colors
Objective Lens: 30 mm

Opera & Sport Glasses

Coated Optics

made in Japan

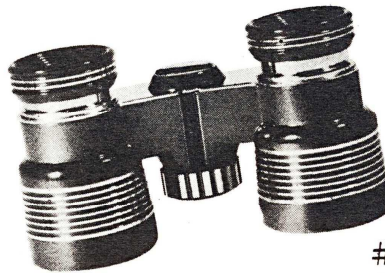

#615

3x Mayflower

with **CENTER BREAK**
matching case, assorted colors
Objective Lens: 28 mm



4x30 #601

Mayflower FIELD GLASS

with **CENTER BREAK**

#605

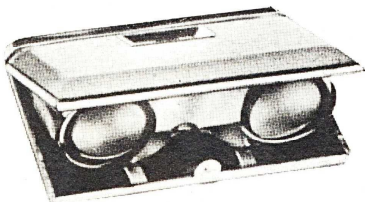

2.5x Mayflower FOLDING GLASS

Leather covered assorted colors

Objective Lens: 28 mm

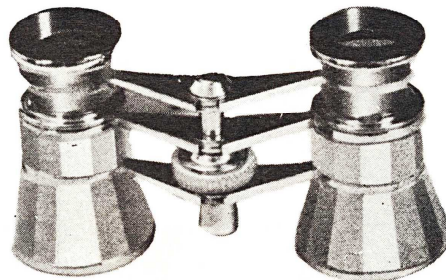

#618 **3x Mayflower**

MOTHER OF PEARL OPERA GLASS

White w. Gold **CENTER BREAK**

Objective Lens: 25 mm

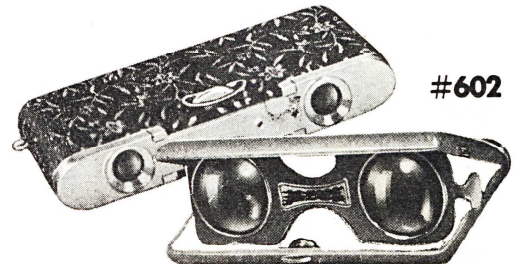

#602

3.5x Colonial FOLDING GLASS

Brocade or Leather covered
assorted colors

Objective Lens: 28 mm

Furnished with CASES, Gift boxed.

7.

COLONIAL OPTICAL COMPANY

1954 SOUTH LA CIENEGA BLVD ★ LOS ANGELES 34 CALIF.

MAYFLOWER

TELESCOPES

Coated Optics
made in Japan

#827

HAND TELESCOPE
30 x 30



#801

VARI-POWER TELESCOPE
10-15-20-25-30 x 30

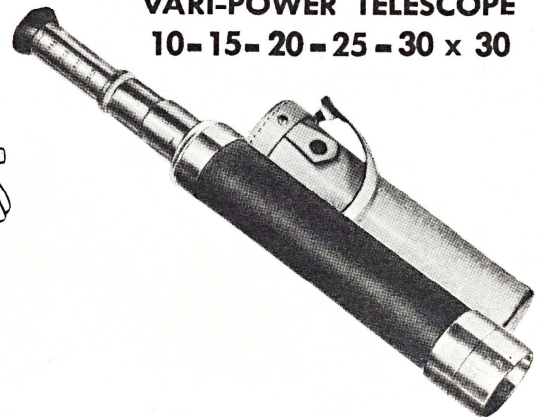

#805

20-30-40-60x 60
VARI-POWER PRISMATIC TELESCOPE
with 4 Eyepieces on Turret

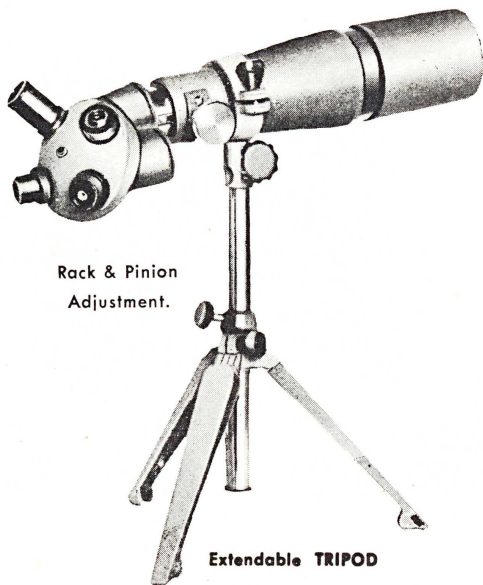

Rack & Pinion
Adjustment.

Extendable TRIPOD

#803

30 x 40 TELESCOPE

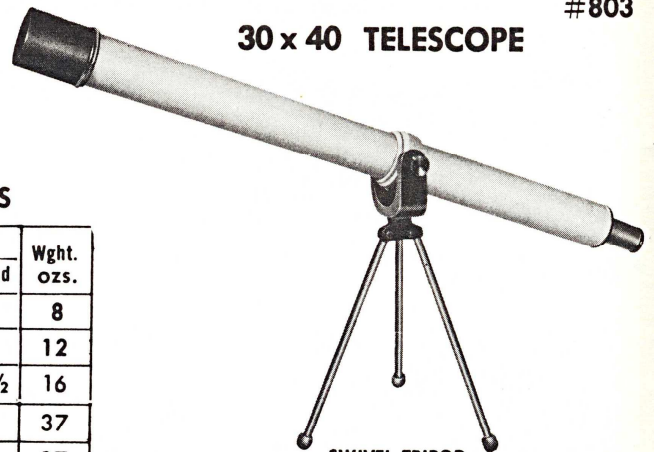

SWIVEL TRIPOD

SPECIFICATIONS

No.	Power	Objective	Length		Wght. ozs.
			Closed	Extended	
827	30x	32	8"	17"	8
801	10-30x	32	8"	17"	12
803	30x	40	16"	20½"	16
805	20-60x	60	18"	18"	37
806	15-60x	60	28"	28"	37

#806

15-30-45-60x 60
VARI-POWER TELESCOPE



Rack & Pinion
Adjustment.

Extendable SWIVEL TRIPOD: 31" to 63".

MANUAL

#71



"Discover the Stars"

#75

TELE'DAPTER



Camera Adapter for
taking pictures
through telescope.

8.

MB

COLONIAL OPTICAL COMPANY

1954 SOUTH LA CIENEGA BLVD. ★ LOS ANGELES 34, CALIF.

MAYFLOWER

ASTRONOMICAL TELESCOPES

Coated Optics

280x REFRACTING TELESCOPE

35 - 140x
70 - 280x
2x BARLOW LENS
5x View Finder

#814

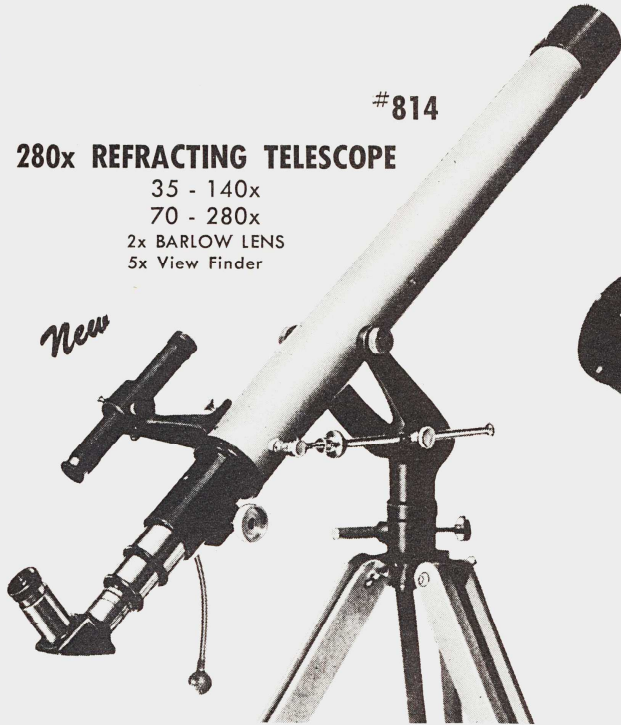

Objective L: 60mm dia., 700mm focal length
2 Eyepieces: 5mm (140, 280x) 20mm (35, 70x)
Accessories: Diagonal Prism, Erect. Prism
Barlow L, View Finder, Sun Filter,
Slow Motion Control, Wooden Box.

TRIPOD extends to 5 ft. height

#821

4" REFLECTOR 300x

90 - 150x
180 - 300x
2x BARLOW LENS
5x View Finder



Mirror: 4" dia., 900mm focal length
2 Eyepieces: 6mm (150, 300x), 10mm (90, 180x)
Accessories: Barlow L, Sun & Moon Filter
View Finder.

TRIPOD extends to 5 ft. height

117x REFRACTING TELESCOPE

55 - 117x
5x View Finder

#813



Objective L: 60mm dia., 700mm focal length
2 Eyepieces: 6mm (117x) 12½mm (55x)
Accessories: Diagonal Prism, View Finder,
Sun Filter.

TRIPOD extends to 5 ft. height

MB

454x REFRACTING TELESCOPE

46-73 - 152-227x
92-146-304-454x
2x BARLOW LENS
EQUATORIAL MOUNT
Minute Motion Adjustment
6x View Finder

#815



Objective L: 60mm dia., 910mm focal length
4 Eyepieces: 4mm (227, 454x), 6mm (152, 304x)
12½mm (73, 146x), 20mm (46, 92x)

Accessories: Diagonal Prism, Erecting Prism
Barlow L, View Finder, Sun Filter
Sun Project. Screen, Wooden Box
2 Slow Motion Controls.

TRIPOD extends to 5 ft. height

600x REFRACTING TELESCOPE

60-96-200-300x
120-192-400-600x
2x BARLOW LENS
EQUATORIAL MOUNT
Minute Motion Adjustment
6x View Finder

#816

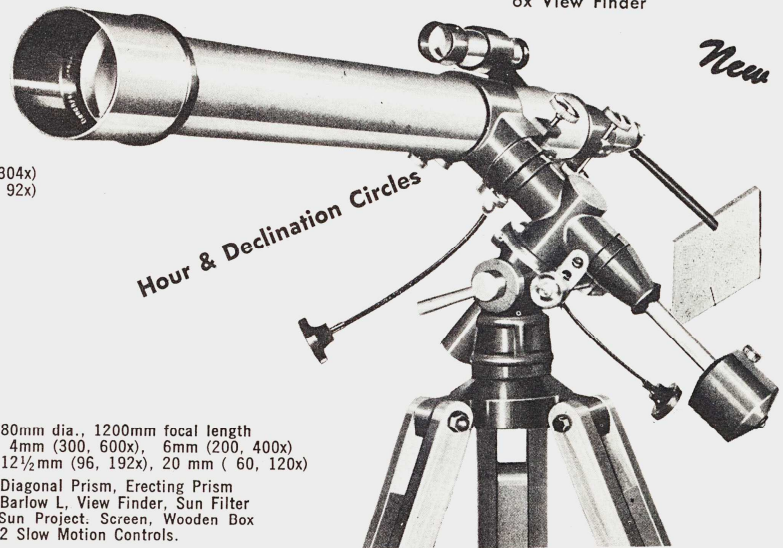

Objective L: 80mm dia., 1200mm focal length
4 Eyepieces: 4mm (300, 600x), 6mm (200, 400x)
12½mm (96, 192x), 20mm (60, 120x)

Accessories: Diagonal Prism, Erecting Prism
Barlow L, View Finder, Sun Filter
Sun Project. Screen, Wooden Box
2 Slow Motion Controls.

TRIPOD extends to 5 ft. height

COLONIAL OPTICAL COMPANY

1954 SOUTH LA CIENEGA BLVD. ★ LOS ANGELES 34, CALIF.

MAYFLOWER

RIFLESCOPES

Coated Optics
made in Japan



Now

Nitrogen filled

Zoom

#812



4 - 9 x
"ZOOM" RIFLESCOPE

- Objective Lens ● 40 mm
- Field of View ● 33' at 100 yds at 4 x
- Eye Relief ● 3 1/4"
- Length ● 13"
- Tube diam ● 1"
- Weight ● 14 ozs.



With Elevation and
Windage adjustment.



CROSS HAIR
Reticle.

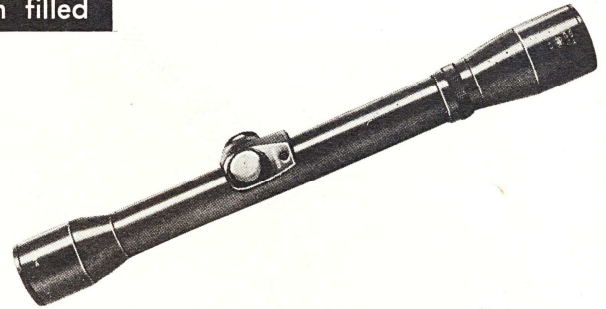

4 x RIFLESCOPE #811

- Objective Lens ● 32 mm
- Field of View ● 33' at 100 yds
- Eye Relief ● 3 1/4"
- Length ● 12"
- Tube diam ● 1"
- Weight ● 11 ozs.

MAYFLOWER

SPOTTING SCOPES

Coated Optics
made in Japan



#802

30 x 60 SPOTTING SCOPE

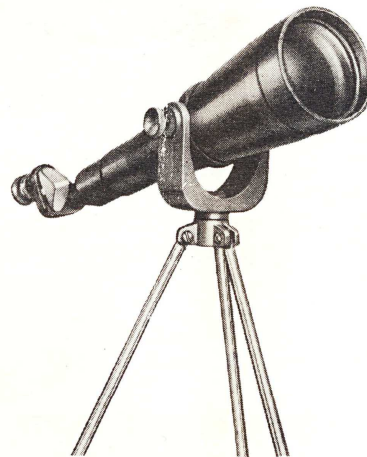

SWIVEL TRIPOD

#800
20 x 40 SPOTTING SCOPE

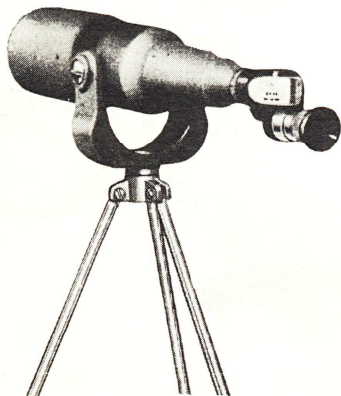

SWIVEL TRIPOD

#805

20 - 30 - 40 - 60 x 60

PRISMATIC

VARI-POWER SPOTTING SCOPE

with 4 Eyepieces on Turret

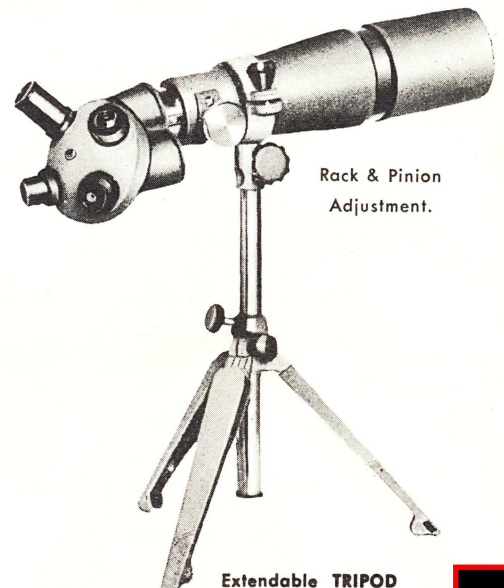

Rack & Pinion
Adjustment.

Extendable TRIPOD



COLONIAL OPTICAL COMPANY

1954 SOUTH LA CIENEGA BLVD. ★ LOS ANGELES 34, CALIF.

READERS AND MAGNIFIERS

With precision ground, highly polished lenses.

MB

#867



GOOSENECK

4x STAND MAGNIFIER

Lens: 4" dia. — 4 Diopter
Flexible shaft adjustable to any position.
Chrome plated on black enamel base.

#866

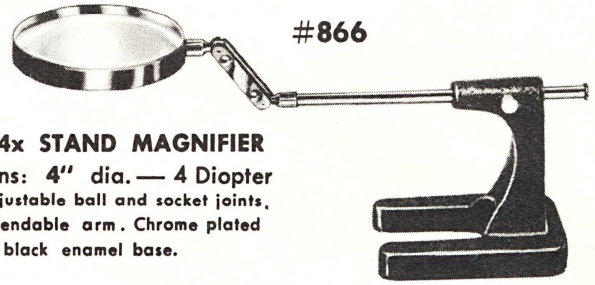

4x STAND MAGNIFIER

Lens: 4" dia. — 4 Diopter
Adjustable ball and socket joints.
Extendable arm. Chrome plated on black enamel base.

#859

LINEN TESTER

6x, base opening 1x 1"
With 2 lenses and graduated base.
Brass, black smoke finish.

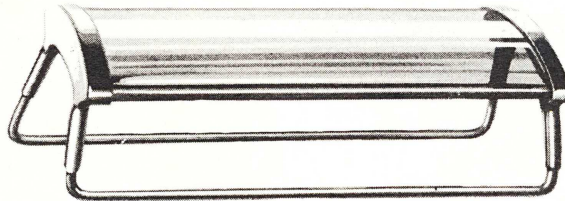

RECTANGULAR READING BENCH

Nickel finished frame, can be folded flat.

#860 4" x 1 1/2"

#861 6" x 1 5/8"

#850

4x POCKET MAGNIFIER

1 3/4" dia. lens,
Swings out of leather case.

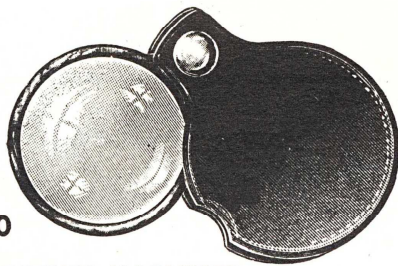

#854

2 x 4" RECTANGULAR READING GLASS

4 Diopter
Chrome plate with black Ebony Handle.

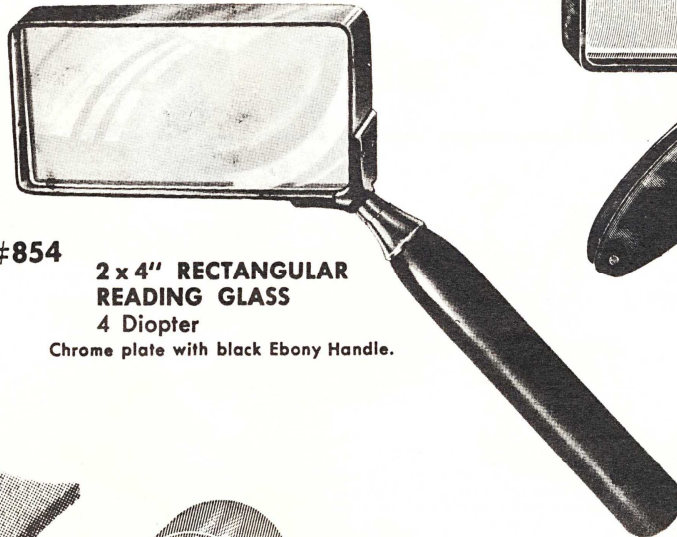

#864

FOLDING READING GLASS

2 x 4" — 4 Diopter
plastic frame,
folding handle.

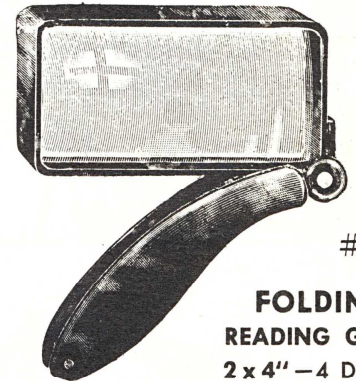

Chrome plated with black Ebony handle.

#852 3" READER

#853 4" READER

#873 3 1/4" READER Extra strong

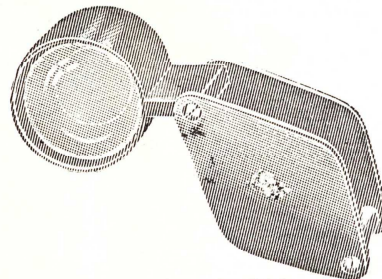
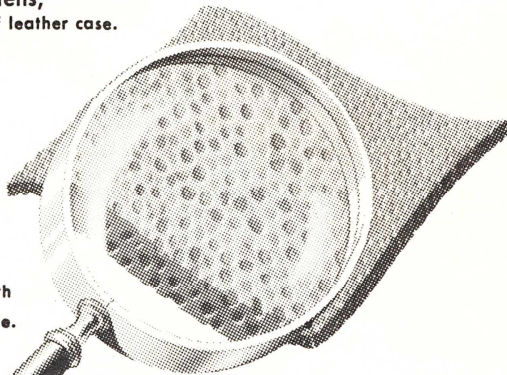

ACHROMATIC LOUPES

#855 10x — #865 16x
5/8" lens dia.



#851

4-8-12x TRIPLE MAGNIFIER
3 Bi-Convex lenses, ea. 1" dia.

MAYFLOWER

ILLUMINATED MICROSCOPES

Microscope Sets contain Dissecting Kit

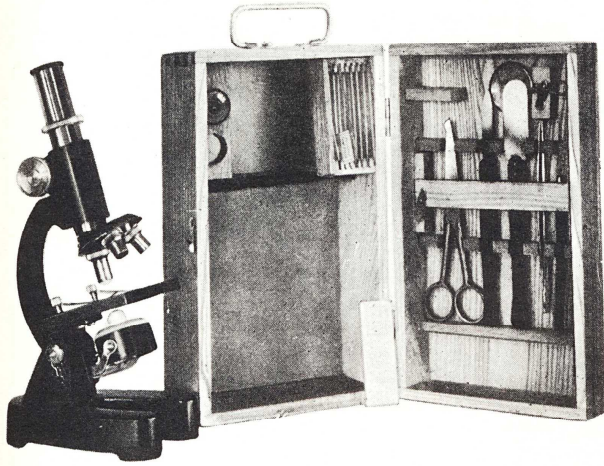

1200 x
LABORATORY
MICROSCOPE SET
With Dissecting Kit
QUADRUPLE TURRET

New

#757

coarse and
fine adjustment.

OPTICAL DATA

Eyepieces	Objectives	Magnification
10 x	8 x	80 x 160 x
20 x	10 x	100 x 200 x
	40 x	400 x 800 x
	60 x	600 x 1200 x

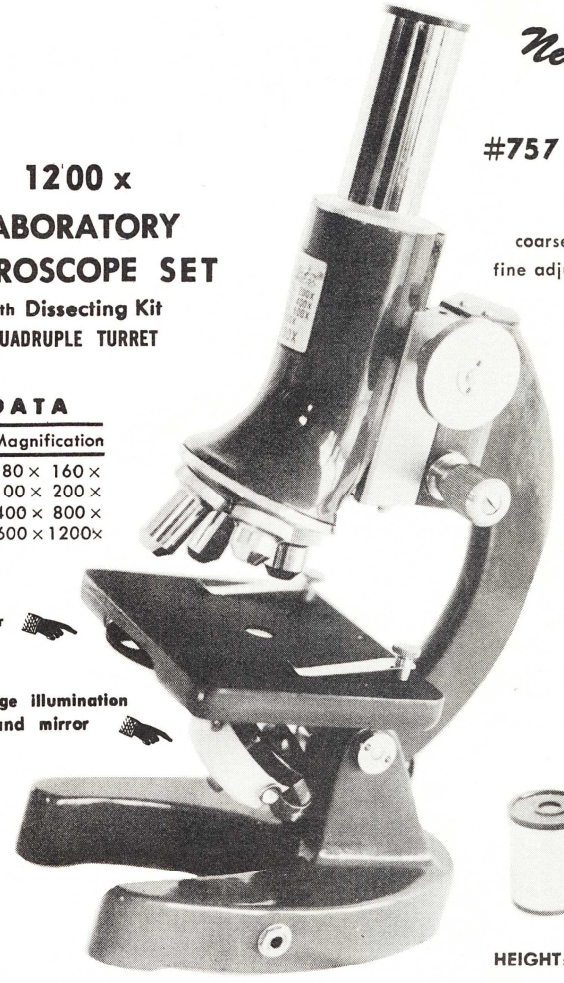

Condenser

Substage illumination
and mirror



HEIGHT: 10"

Transformer jack

MB

Substage illumination
(2 pen lite batteries
not furnished).



New

#756
750x
STUDENT MICROSCOPE SET
With Dissecting Kit
QUADRUPLE TURRET

OPTICAL DATA

Eyepieces	Objectives	Magnification
10 x	10 x	100 x 150 x
15 x	20 x	200 x 300 x
	30 x	300 x 450 x
	50 x	500 x 750 x

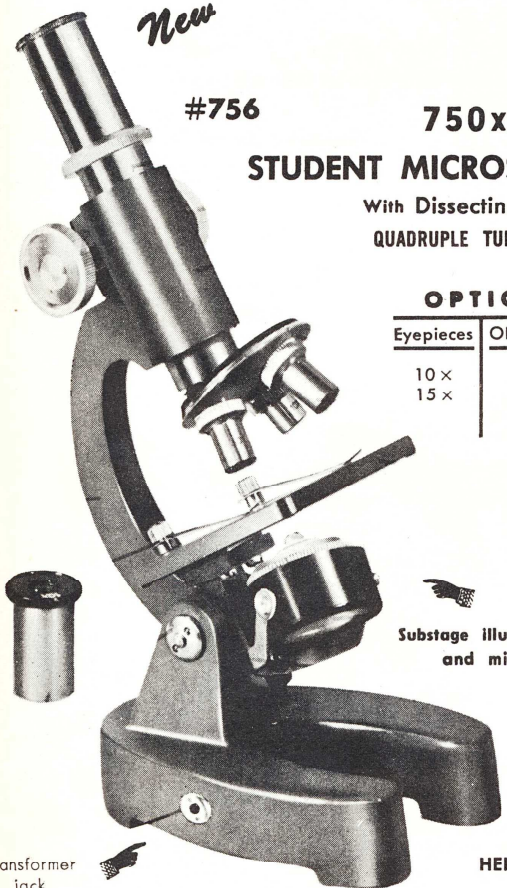

Substage illumination
and mirror

Transformer
jack

HEIGHT: 9"

600 x
STUDENT MICROSCOPE SET
With Dissecting Kit
TRIPLE TURRET

#755

New

OPTICAL DATA

Eyepieces	Objectives	Magnification
15 x	10 x	150 x 300 x
	20 x	600 x
	40 x	

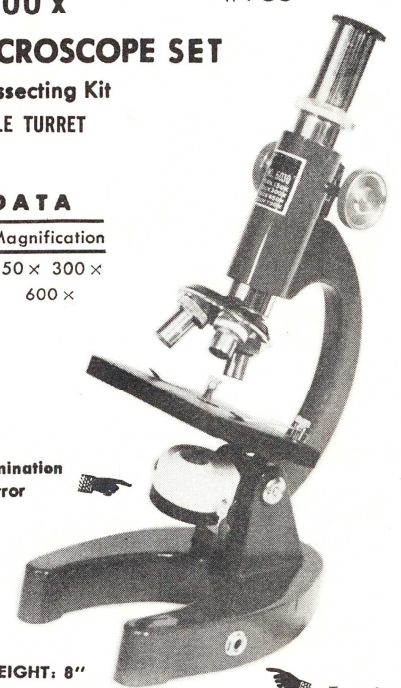

Substage illumination
and mirror

HEIGHT: 8"

Transformer jack

13.

COLONIAL OPTICAL COMPANY

1954 SOUTH LA CIENEGA BLVD. ★ LOS ANGELES 34, CALIF.

IMPORTED FROM
GERMANY

Colonial **BAROMETERS**

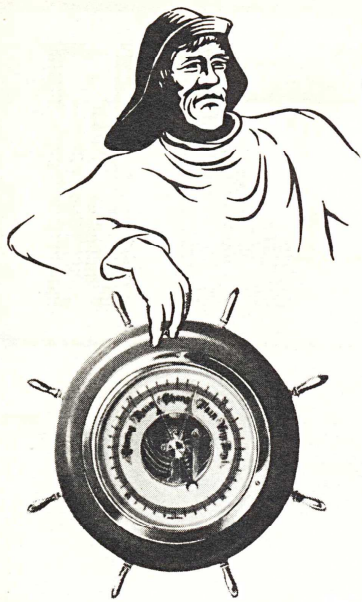

#902
SHIP WHEEL BAROMETER
Mahogany or blond finished wood, 8 brass spokes, enamel dial. DIAL: 3 1/4", FRAME: 5 1/4" with detachable easel for desk or wall.

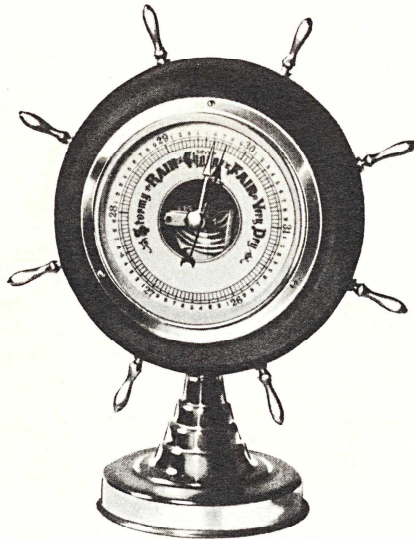

#916
DESK BAROMETER — SHIP WHEEL
On all brass base with 8 spokes. DIAL: 4" FRAME 5 1/4 x 8 1/2"

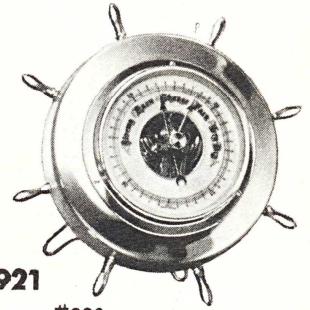

#921
Same as #902 in all brass

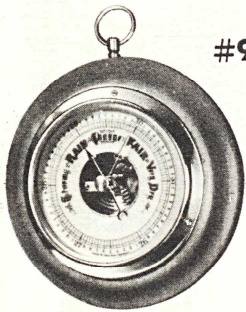

#900
STANDARD BAROMETER
Mahogany or blond enamel dial, DIAL: 3 1/4" FRAME: 5 1/4"



#903
DE LUXE BAROMETER
A large wall Barometer with enamel dial. Mahogany, walnut or blond finish. DIAL: 5 1/4", FRAME: 7 1/4"

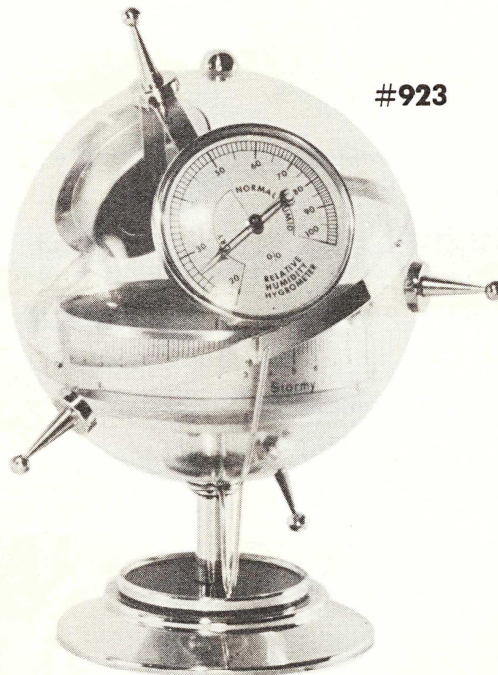

#923
SATELLITE WEATHER STATION
Meteorological observatory
Barometer · Hygrometer · Thermometer
Three precision instruments mounted in plexiglass housing. — On all brass base, with brass dials.

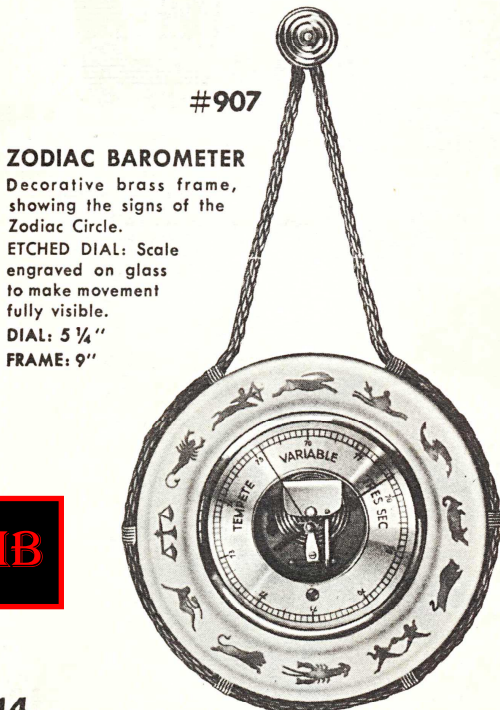

#907
ZODIAC BAROMETER
Decorative brass frame, showing the signs of the Zodiac Circle.
ETCHED DIAL: Scale engraved on glass to make movement fully visible.
DIAL: 5 1/4" FRAME: 9"



#904
DISC BAROMETER of magnificent design. Dome-shaped glass framed by brass housing with matching dial. DIAL: 5 1/2", Frame: 6 1/4".
Side View

MB

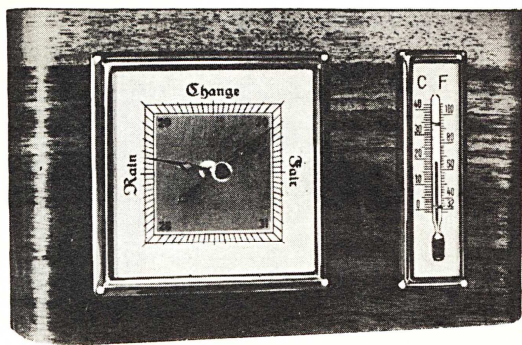

#918 Barometer-Thermometer
Two instruments mounted on walnut panel for desk or wall use.
DIAL: 4 x 4", PANEL: 8 1/2 x 5 1/2"

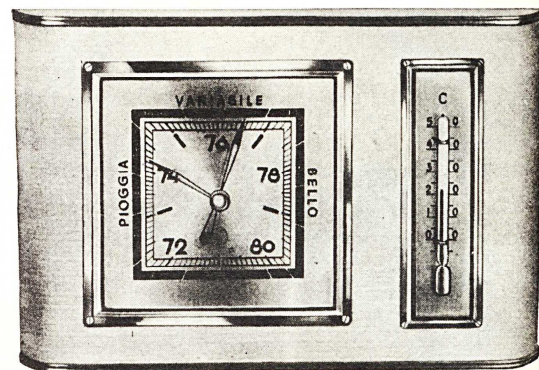

#919 Barometer-Thermometer
Two instruments mounted on gold panel for desk or wall use.
DIAL: 4 x 4", PANEL: 8 1/2 x 5 1/2"

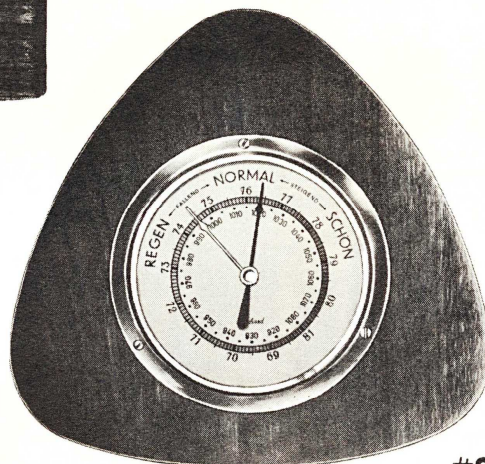

#927 Barometer
Barometer mounted on bowl-shaped walnut panel of streamlined design.
DIAL: 3 1/2", FRAME: 6 1/4 x 6 1/4"

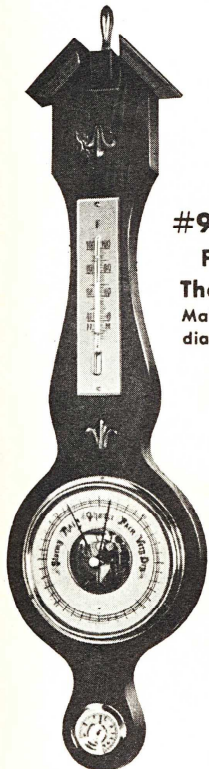

#925 PENDANT BAROMETER
Thermometer - Hygrometer
Mahogany, walnut finish, enamel dial. DIAL: 4", FRAME: 20"

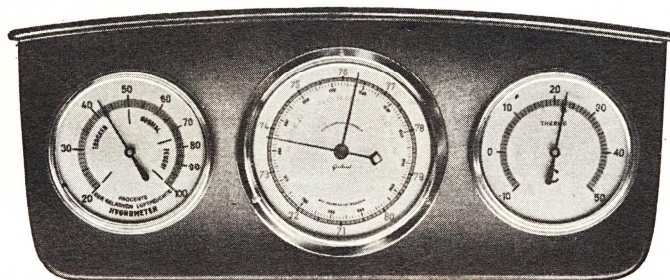

#928 WEATHER STATION Barometer — Thermometer — Hygrometer.
BAROMETER: 3 1/2", THERMO & HYGROMETER: 2 3/4"
Three precision instruments mounted on 12 1/2 x 5" rounded walnut panel. Instruments with satin finished brass dials. A deluxe desk or wall Barometer.

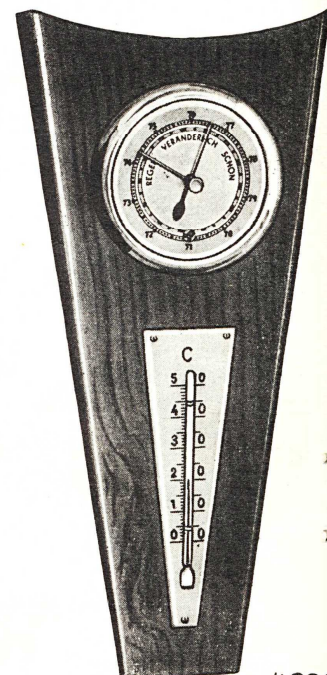

#920 Barometer-Thermometer
Two instruments mounted on tapered walnut panel of streamlined design.
DIAL: 2 3/4", FRAME: 5 1/4 x 11" high.

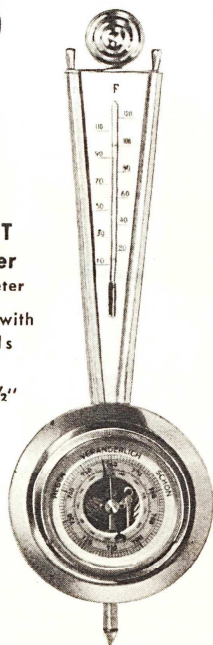

#926 PENDANT Barometer
w. Thermometer
Brass frame with silvered dials
DIAL: 3 1/2"
FRAME: 16 1/2"

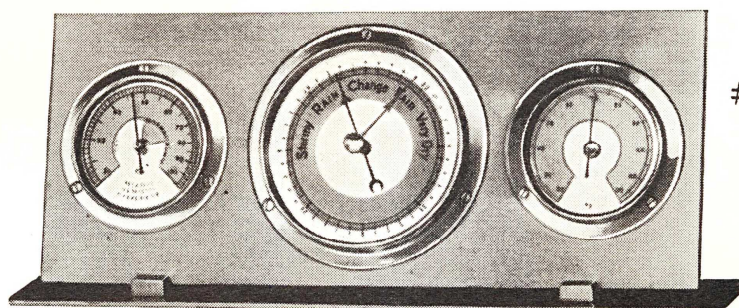

#922 DESK COMBINATION Barometer - Thermometer - Hygrometer.
Three precision instruments on polished all brass mount.
DIALS 2 3/8" PANEL: 8 1/4 x 3 5/8"



MB



Return Postage Guaranteed

COLONIAL OPTICAL COMPANY

Direct Importers

1954 SO. LA CIENEGA BLVD.
LOS ANGELES 34, CALIF.



1-13

Robbie's Sport Center
~~173 Chestnut St.~~
Meadville, Penna.

DISTRIBUTOR'S PRICE LIST

JULY 1961

ITEM No.	MICROSCOPES	COST
755	600 x STUDENT MIC-SET w. Light, Dissecting Kit, Wood Box	3.95
756	750 x STUDENT MIC-SET w. Light, Dissecting Kit, Wood Box	5.75
757	1200 x LABORATORY MIC-SET w. Light, Dissecting Kit, Wood Box	12.75
761	1200 x PROFESSIONAL MICROSCOPE, Standard Optics, Wood Box	39.95
60	PREPARED SLIDES (min 3)	.75
62	TRANSFORMER	1.45
63	MICROSCOPE LAMP	1.95
64	MECHANICAL STAGE, Graturated	4.75
65	CAMERA ADAPTER	10.95
70	MANUAL	.75
READERS & MAGNIFIERS		
850	4 x POCKET MAGNIFIER round 1 1/4"	3.25 doz
851	4-8-12x TRIPLE MAGNIFIER round 1"	(ea. .35) 5.75 doz
852	3" READER round	.80
853	4" READER round	1.30
873	4" READER round, Extra Strong	1.55
854	2 x 4" READER rectangular	1.65
864	2 x 4" READER rectangular w. Folding Handle	1.85
860	4 x 1 1/2" READING BENCH rectangular	2.75
861	6 x 1 1/2" READING BENCH rectangular	3.25
855	10x LOUPE achromatic	1.50
865	16x LOUPE achromatic	1.75
866	4" STAND MAGNIFIER	5.50
867	4" STAND MAGNIFIER	5.50
859	6x LINEN TESTER 1x1" base opening	1.65
BAROMETERS German		
900	STANDARD BAROMETER mahag, blond, Wall 5 1/2"	2.75
902	SHIP WHEEL BAROMETER " " Wall 5 1/2"	3.50
903	LARGE SIZE BAROMETER " " Wall 7 1/2"	4.75
904	BRASS DISC BAROMETER all brass Wall 6 1/4"	7.95
907	Z O D I A C BAROMETER etched dial, Wall 9 1/2"	7.95
916	SHIP WHEEL BAROMETER Desk 8 1/2x8	6.95
921	SHIP WHEEL BAROMETER all brass Desk, Wall 5 1/2"	4.50
927	BOWL SHAPE BAROMETER walnut Wall 6 1/2x6 1/4"	6.95
918	BAROMETER-THERMOMETER walnut Desk, Wall 8 1/2x5	4.95
919	BAROMETER-THERMOMETER gold color Desk, Wall 6 1/2x5	4.95
920	BAROMETER-THERMOMETER walnut Pendant 11	7.75
926	BAROMETER-THERMOMETER brass Pendant 16	7.95
925	BAROMETER-THERMOMETER-HYGROM. brass, Desk 20	8.95
922	BAROMETER-THERMOMETER-HYGROM. brass, Desk 8 1/2x3 1/2	9.50
923	BAROMETER-THERMOMETER-HYGROM. Satellite, Desk 8	12.50
928	BAROMETER-THERMOMETER-HYGROM. walnut D & W 12 1/2x5	11.95

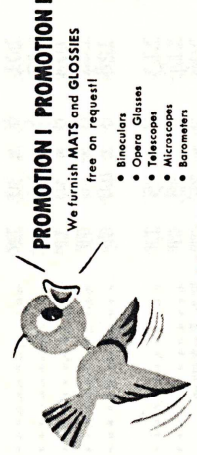
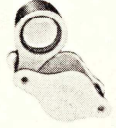
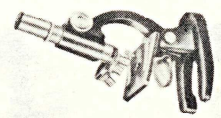

PROMOTION I PROMOTION I
We furnish MATS and GLOSSIES free on request!

- Binoculars
- Opera Glasses
- Telescopes
- Microscopes
- Barometers

Make use of them for:

- Racing Season
- Hunting Season
- Ball Games
- Mother's Day
- Father's Day
- Graduation Time
- Vacation Time
- Back to School
- Christmas

Plan a promotion program of four campaigns a year! It will pay you well!

Fully Coated

The engraving "FULLY COATED" on our Binoculars is your guarantee that all light transmitting surfaces are coated. Uncoated or partially coated Binoculars cannot be engraved "Fully Coated".

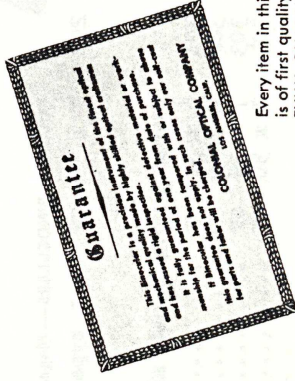

Every item in this catalog is of first quality and FULLY GUARANTEED.

ALL BINOCULARS furnished with HARD CASES.
TERMS: NET 30 days f.o.b. our warehouse.
Prices subject to change without notice.

